

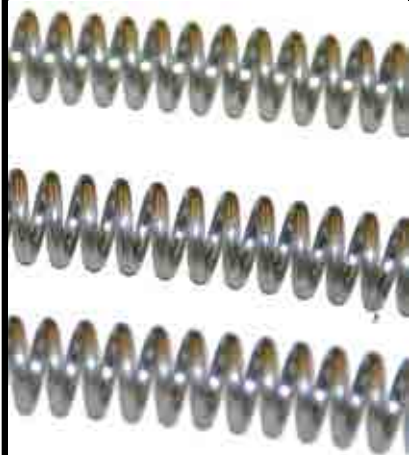

SKUTT

CERAMIC KILN CATALOG

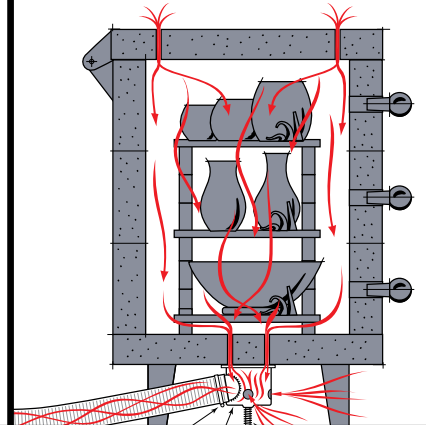

We help you make great things!

skutt.com

Whatever you create,

From teachers to artists to production studios

Schools



Skutt has long been the number one kiln brand chosen by Art Teachers across the country. Our reputation for **durability** and **ease of use** are just some of the reasons teachers choose Skutt over any other brand in the industry.



Ten teachers, over 30 awards between them and all use Skutt Kilns.

When budgets and deadlines are tight, teachers know they can count on Skutt to give them the **value** and **dependability** to keep their clay program strong and effective. Backed by the **Best Warranty** and **Customer Support** in the industry, teachers know they can count on Skutt.



Studio Pot-



Studio Potters have long considered Skutt the **Premier Brand** in the industry. Side by side with other brands, it is easy to see the **superior craftsmanship** in a Skutt. From the precision cut brick to corrosion resistant materials throughout it's construction, quality and long life are unsurpassed. The **precision** and **flexibility** of the KilnMaster Controller have made **innovation** not only possible, but inevitable.



visit skutt.com to see our selection of Potter's Wheels!

Skutt helps bring it to life.

s, people who require quality use Skutt kilns.

Hobby Ceramics



Sculptors, slip casters, hobby potters, slab builders... **Whatever your hobby**, Skutt has a kiln for you. Skutt's wide range of shapes and sizes ensures you can find a kiln that exactly fits your needs.



Our **Customer Service Team** and International Network of **Ceramic Distributors** are there to help you work through any new challenges. **Our website**, complete with **How-To Videos**, will walk you through most kiln issues **24/7**.

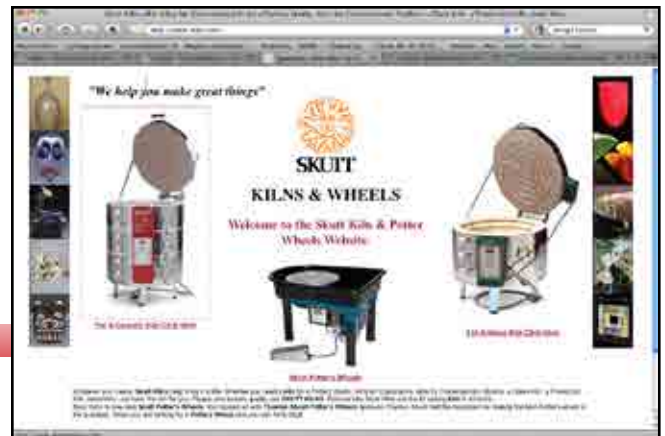

Manufacturing

In order to compete in today's world of Manufacturing, a company needs to be both **efficient** and **flexible**. Ceramic Manufacturers, especially in the tile industry, enjoy the benefits of firing multiple Skutt kilns instead of larger kilns usually associated with Ceramic Manufacturing because they can **fire** and **grow** exactly to their needs. If one kiln is down, they do not lose half of their production and because Skutt ships most parts **within 24 hours**, they are up and running in no time.



Make the smart choice

The Thermocouple

- A great thermocouple must be **responsive and accurate**.
- The **low mass** of Skutt thermocouples ensures that changes in temperature are measured quickly making it one of the most responsive thermocouples on the market today.
- At Skutt we use only thermocouples with **special limit wire**. This is the most accurate wire available for Type K thermocouples.
- The optional **Type S** thermocouple is constructed of a material that will not degrade in most atmospheres. It is very **resilient to high fire temperatures** and therefore can last a very long time under extreme conditions.

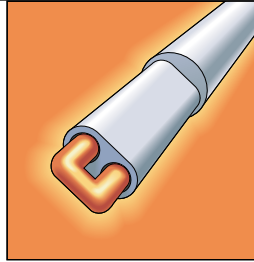

The Brick

- **Skutt hand selects the brick** that will be used in every kiln. The brick is then milled within a very tight specification so you are guaranteed a precision fit.
- Compare a Skutt kiln to any other kiln on the market and **you can see the difference**.



The Stand

- Our stands are welded, not bolted together, to ensure **maximum stability**. This sturdy, welded construction also means that **no assembly is required**. Optional heavy duty, rolling stands are also available.

The Elements

- More elements in the wall of the kiln chamber means **more uniform heat radiation**, and more options for placing shelves. Skutt kilns have elements every 2.25".
- **Skutt balances the heat flow** in the kiln by placing hotter elements in the areas that need it. This improves the efficiency and heat uniformity of the kiln and eliminates the need for zone control in most applications. Zone control can unnecessarily extend firing times and requires more maintenance.
- Our elements are computer designed to use the heaviest wire gauge to minimize watt density. The result is an element that will **run strong firing after firing**.

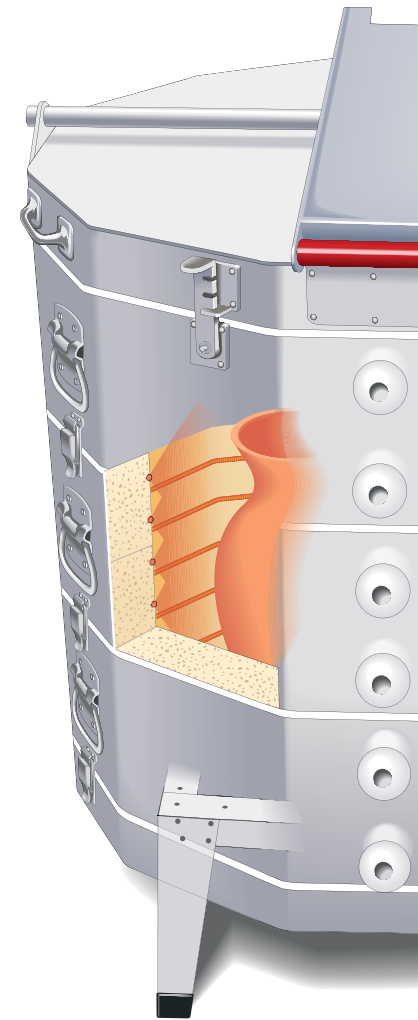

Heat Distribution

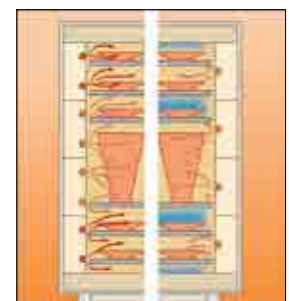

Ours

Theirs

Find out **why** SKUTT is the number one selling kiln in America



The Sectional Design



- Skutt kilns ship fully assembled, however, they can be **quickly disassembled** in order to move through narrow doorways or down stairs. A Skutt kiln can be disassembled and put back together in less than 10 minutes.
- Others have tried to imitate our sectional design but no one is able to match the **quality and ease** of Skutt.

Smart Materials

- Every component, from the handle on the lid to the screws in the control box, is made of **corrosion-resistant materials** to protect and extend the life of the kiln. The control box is powder coated for excellent protection from scratches.

The Lid

- All Skutt 10 and 12 - Sided kilns come with a **Lid Lifter as a standard feature**. These spring-assisted lids are so light you can lift them with a finger. Compare them to other brands and you will **feel the difference**.
- Every Skutt lid is coated with a strong, long lasting refractory cement that prevents brick dust from falling into the kiln and improves the lid's structural integrity. Since both sides are coated, the **lid can be reversed for double the life**.
- A 2-position lid brace and 3-position lid prop are included for additional **safety and convenience**.



The Controller

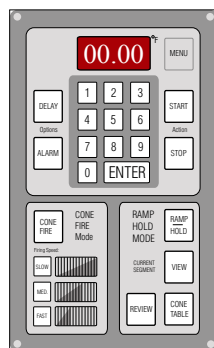

- We believe our controller has the **most user-friendly layout** available. Dedicated keys make accessing features straight forward and easy to follow. Even the most sophisticated programs can be entered by a novice.
- New **Current Sensing Technology** makes it possible for our technicians to troubleshoot your kiln right over the phone saving you money and time on repairs.
- Features include Pre-Heat, Delay, Alarm, Cone Fire, Ramp & Hold, Program Storage, Monitors Firing Costs and Number of Firings and is **KilnLink Ready**. Welcome to the future of firing!

The KilnMaster™

Electronic precision and control

Ease of Programming

The KilnMaster Controller gives you the option of two different firing modes.

■ Cone Fire Mode

Cone Fire Mode does all the heavy lifting for you by running programs pre-designed by Ceramic Engineers to safely progress through sensitive temperature zones. The program will actually sense how fast or slow your kiln is firing and adjust the ending temperature to give you Perfect Cone Correlation. All you have to do is enter the following basic information:

- Pre-Heat Time
- Cone Value
- Firing Speed
- Hold Time

Example of Medium Speed Cone Firing to Cone 04

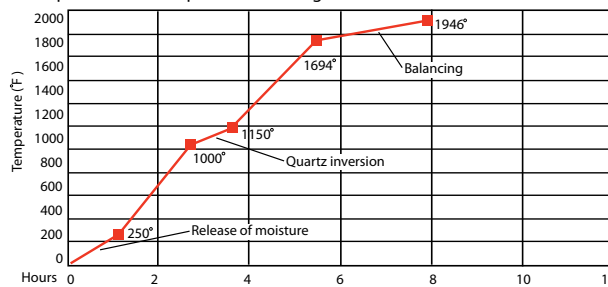

■ Ramp/Hold Mode

Ramp/Hold Mode gives you the freedom to design your own firing programs of up to 64 segments. Each segment consists of a temperature rate, peak temperature and a holding time at the specified temperature. You can store up to 12 profiles for easy recall. These capabilities are essential for techniques with unique requirements like Crystal Glazes and Fusing Glass.

- Program #
- # of Program Segments
- Rate, Temperature, and Hold Time for each segment

Segment	Rate	Temperature	Hold
1	200°/hr	800 °F	0
2	150°/hr	1250 °F	0
3	300°/hr	2100 °F	0
4	108°/hr	2345 °F	0
5	9999°/hr	2050 °F	3.00

Example shows a typical Ramp/Hold profile for a Cone 10 crystal glaze firing.

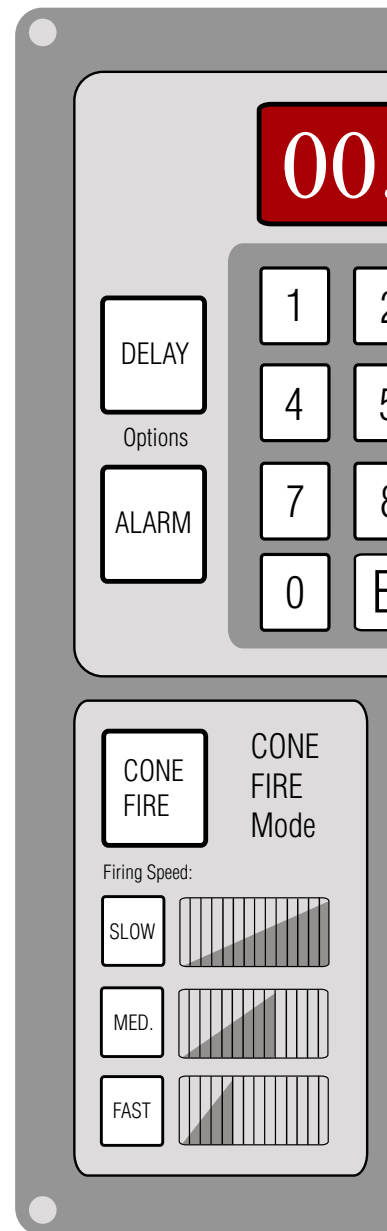

Advanced Features

- Troubleshooting Error Codes and Procedures
- Controlled Cooling in Cone Fire Mode
- Cone Correlation in Ramp/Hold Mode
- Type S or Type K Thermocouples Settings

Safety Features

- Maximum Temperature Setting to prevent accidental overfires.
- Double Key Press Start to prevent anyone from accidentally (or maliciously) starting the kiln.

Automatic Kiln Line

venience with our KilnMaster Controller

Key Features

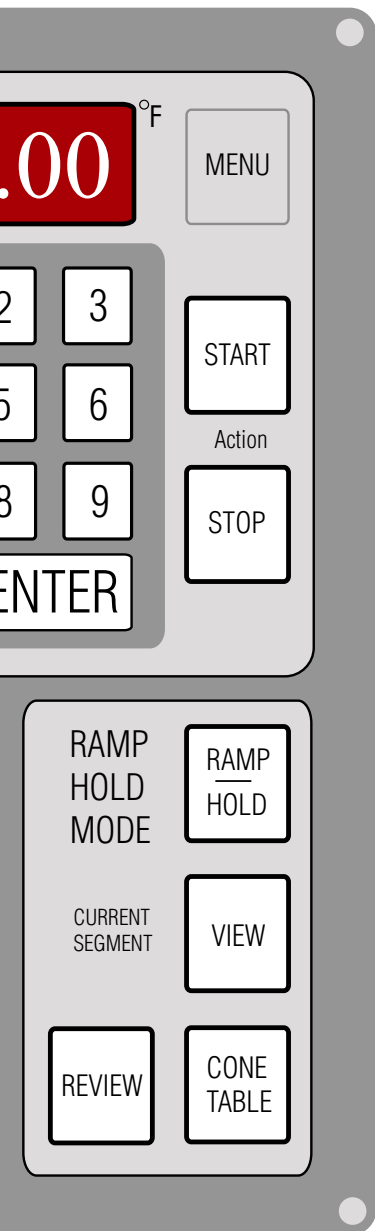

- Preheat - Allows you to slowly heat greenware to eliminate residual moisture in the clay and reduce the chances of cracking. Once the Preheat cycle is complete, the Cone Fire Program will automatically begin.
- 64 Segment Programs - Now you can join two Ramp/Hold Programs together to create up to 64 segments.
- 12 Storable Programs - Store up to 12 of your favorite Ramp/Hold programs to easily recall without the need to re-enter them.
- Delay Start - Tired of getting up at 3:00 in the morning to see if you kiln shut off ok? Go ahead and load your kiln, enter an amount of time to delay the start of the program and press Start. The controller will count down the delay time entered and start the kiln at a time when it will complete the firing when it is convenient for you.
- Alarm - The temperature alarm can be programmed to sound at any temperature during the firing.
- Review - It is always good to Review a program to make sure you entered it correctly. Review will step through the program currently entered and return to Idle.
- NEW** Monitor Electrical Costs - Just enter your cost per Kilowatt/Hr and the controller will calculate the total cost of each firing.
- NEW** Tracks the Number of Firings - Just press review and it will tell you how many firings the kiln has completed.
- NEW** KilnLink Ready Software - All new KilnMaster kilns come equipped with software that will work with KilnLink, the new kiln monitoring system that allows you to check the status of your kiln from anywhere you have an internet connection.

Current Sensing

- Skutt Kilns are one of only a few kiln brands that has Current Sensors standard. The sensors allow you to actually test your Amperage and Voltage without the need to hire and schedule time for an electrician to come out. With these readings our technicians can troubleshoot most problems over the phone **Saving You Money and Time.**

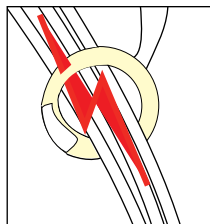

Free Instructional DVD

- Every KilnMaster kiln comes with an instructional video which will guide you from setting up your kiln all the way through the programming of your first firing.



Check out our "Build A Kiln" feature at www.skutt.com

Select the right

Your Skutt kiln should be with you for quite some time, therefore it is important to select the model that will meet your needs now and in the future. Many choices must be made and the process can seem intimidating if you've never purchased a kiln before. To help in your selection process, we have constructed a series of questions that should help you narrow your search to the models which will work best for you.

About Skutt Nomenclature

The chart below helps illustrate how to interpret the information found in a kiln's model number. For examples we have used a KM1227-3PK and a KS818

Controller Options	Brick Around	Chamber Dimensions Depth in Inches	Brick Thickness	Other Options
KM	12	27	-3	PK
KS	8	18		

Controller:

KM = KilnMaster (automatic controller)
KS = KilnSitter (manual controller)

Chamber Dimensions:

After the controller designation, the next 3 or 4 digits describe the chamber size. The first 1 or 2 digits refer to the number of bricks used in each row of bricks. This determines the kiln's width. The other 2 digits refer to the kiln chamber depth in inches.

Brick Thickness:

-3 = 3 inch brick. If -3 is not present in the model name it has standard 2-1/2" brick.

Other Options:

PK = Production Kiln
ZC = Zone Control
30A = Designed to run on a 30 amp breaker (KM model)
P = Designed to run on a 30 amp breaker (KS model)

1. Determine Available Space

Skutt kilns need minimum 18" clearance from walls on all sides. The outside measurements of the kiln can be determined by the number of sides of the kiln. As mentioned in the "About Skutt Nomenclature" box, the first set of numbers in the kiln model number indicate the number of sides in the kiln (example: KM1227-3 = 12 sided, KS818 = 8 sided). The chart below shows the outside width of Skutt kilns.

16 sided	12 sided	10 sided	8 sided	7 sided	6 sided
52"L-37"W	34"	29"	23"	20"	17"

What is the largest kiln that will fit the area you have selected? _____

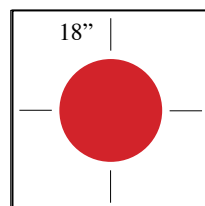

18" clearance is required in all directions from edge of kiln to walls or adjacent kilns.

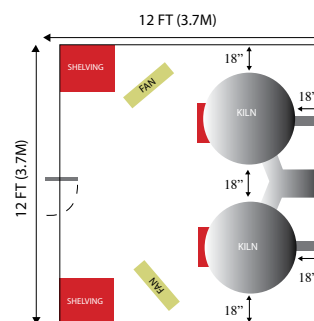

Typical layout for a dual kiln studio.

2. Determine Capacity Needed

Next, you need to find out if the chamber of the kiln will be large enough to fire the pieces you produce. The chart below lists the chamber sizes for each model. The three things to consider when choosing the necessary chamber size are:

- What are the dimensions of the largest piece you will want to fire?
- What is the maximum volume of material you will need to produce in a specific time frame?
- How do you feel your needs will grow in the next five years?

1627-3"	1227-3"	1218-3"	1027*	1018*	818*	714	614-3"	609
46" Length 30.75" Width 27" Depth	28.13" Width 27" Depth	28.13" Width 18" Depth	23.38" Width 27" Depth	23.38" Width 18" Depth	17.5" Width 18" Depth	14.38" Width 13.5" Depth	11" Width 13.5" Depth	11" Width 9" Depth

* Remember that on certain models where 3" brick is an option (not standard) the width of the chamber size will decrease by 1" if you choose to go with the 3" brick upgrade.

Given these considerations, what model has the smallest acceptable chamber size? _____

kiln for you

3. Determine Your Available Power Supply

The next step is to find a kiln that will operate on the electrical service of your building. Ordering a kiln that does not match your electrical service can be very frustrating and expensive to correct. Most people will need to have an electrician install the wire from the circuit breaker panel to the wall receptacle as well as the receptacle. It is also wise to have the electrician verify voltage, amperage and phase when he visits on-site to estimate the job.

Voltage - One of the common misconceptions regarding voltage is that "220" is an actual voltage reading in the U.S.A. Rather, it is used as a generic term for appliances that can run on either 208V or 240V systems. As a general rule, 208V is common in schools and businesses and 240V is common in residential areas. However, exceptions are quite possible.

Amperage - Most buildings have limited amperage available without having the power company upgrade service. In most cases it will be necessary to install a dedicated breaker to run the kiln. Your circuit box or fuse panel must have room for the breaker or fuse that corresponds to the model you choose.

Phase - Kilns can be wired for 1 phase or 3 phase power supplies. 1 phase power supplies have 2 current carrying wires and a grounding wire and are common in residential and industrial areas. 3 phase power supplies utilize 3 current-carrying wires and a grounding wire and are usually only found in businesses and institutions. There are exceptions, and some buildings have both supplies available.

My Voltage

My Max Breaker

My Phase

4. Determine The Firing Temperature Needed

Now we need to find a kiln that will fire to a temperature that meets, and preferably exceeds, the temperature requirements of the materials you will be working with.

Kilns are designed to fire to a variety of temperature ranges. Materials such as porcelain and stoneware require the kiln to reach temperatures up to Cone 10 or 2350 degrees F. Materials such as glass require the kiln to only reach less than 1600 degrees F. Whenever possible, you should choose a kiln that exceeds your firing temperature needs. The use of 3" brick, the voltage, and the phase of a kiln model may affect its maximum rating.

My Max Temperature

5. Choose A Controller

The next step is picking a control device for your kiln. There are two choices: The automatic KilnMaster (KM) and the manual KilnSitter (KS). Consult the information later in this catalog to help decide which is best for you.

KM or KS controller?

6. Accessories And Upgrades

With these questions answered you should now be able to make a well informed decision on the particular model of kiln that will fit your needs. All that's left now is picking the upgrades and accessories you like. Upgrades are shown with the kilns.

Now you have all the information you need for a Skutt distributor to give you a price quote.

For a listing of distributors nearest you, please visit our web site at www.skutt.com

KilnMaster Kilns



KM1227-3"

- The KM1227-3" is Skutt's ultimate low fire production kiln. The 10 cubic foot firing chamber makes it very popular with schools, contemporary studios and production bisque companies.
- When coupled with an EnviroVent, this kiln with its KilnMaster Controller gives precise repeatable firings time after time.
- Lid Lifter and 3-inch brick are standard on this model.



KM1218-3"

- The KM1218-3" provides a big opening and big power, with 6.6 cubic feet capacity and a Cone 10 rating.
- The 28 inch diameter opening allows for large platters.
- Low profile design means easy loading and unloading.
- Lid Lifter and 3-inch brick are standard on this model.

MODEL	PHASE	VOLTS	AMPS	WATTS	CONE	TEMP °F	CU. FT.	OPENING	DEPTH	*SHIP WT LBS	COPPER WIRE SIZE	BREAKER SIZE	NEMA RECEPTACLE CONFIG.
KM1227-3"	1	240	48.0	11520	8	2300	9.9	28.13"	27"	400	6	60	6-50 **
	1	208	48.0	9984	5	2185	9.9	28.13"	27"	400	6	60	6-50**
	3	240	29.3	11520	8	2300	9.9	28.13"	27"	400	8	40	15-50
	3	208	31.7	11000	8	2300	9.9	28.13"	27"	400	8	40	15-50
KM1218-3"	1	240	48.0	11520	10	2350	6.6	28.13"	18"	330	6	60	6-50**
	1	208	48.0	9984	10	2350	6.6	28.13"	18"	330	6	60	6-50*
	3	240	29.3	11520	10	2350	6.6	28.13"	18"	330	8	40	15-50
	3	208	29.5	9984	10	2350	6.6	28.13"	18"	330	8	40	15-50

*SHIPPING WEIGHTS ARE ESTIMATES ONLY

**DIRECT WIRE CANADA



KM1027

- The KM1027 is our most popular and versatile model. With its Cone 10 power and 7 cubic-foot chamber capacity there are very few projects this kiln can't handle.
- An optional 3" brick upgrade makes this model a more efficient high fire kiln and raises the rating for 208 volt models to Cone 10.

(Please note that with added insulation, the chamber diameter is reduced by 1".)



KM1018

- The KM1018 offers the wide capacity of a large kiln coupled with the easy loading height of a smaller kiln. Great for platters!
- It fires to porcelain and stoneware temperatures and has also become a popular glass fusing kiln.
- Optional 3" brick upgrade makes this model a more efficient high fire kiln.

(Please note that with added insulation, the chamber diameter is reduced by 1".)

MODEL	PHASE	VOLTS	AMPS	WATTS	CONE	TEMP °F	CU. FT.	OPENING	DEPTH	*SHIP WT LBS	COPPER WIRE SIZE	BREAKER SIZE	NEMA RECEPTACLE CONFIG.
KM1027	1	240	48.0	11520	10	2350	7.0	23.38"	27"	290	6	60	6-50**
	1	208	48.0	9984	6	2250	7.0	23.38"	27"	290	6	60	6-50**
	3	240	29.3	11520	10	2350	7.0	23.38"	27"	290	8	40	15-50
	3	208	31.7	11000	10	2350	7.0	23.38"	27"	290	8	40	15-50
KM1027-3"	1	240	48.0	11520	10	2350	6.4	22.38"	27"	320	6	60	6-50**
	1	208	48.0	9984	10	2350	6.4	22.38"	27"	320	6	60	6-50**
	3	240	29.3	11520	10	2350	6.4	22.38"	27"	320	8	40	15-50
	3	208	31.7	11000	10	2350	6.4	22.38"	27"	320	8	40	15-50
KM1018	1	240	39.4	9460	10	2350	4.6	23.38"	18"	250	8	50	6-50
	1	208	40.0	8320	10	2350	4.6	23.38"	18"	250	8	50	6-50
KM1018-3"	1	240	39.4	9460	10	2350	4.2	22.38"	18"	275	8	50	6-50
	1	208	40.0	8320	10	2350	4.2	22.38"	18"	275	8	50	6-50

* SHIPPING WEIGHTS ARE ESTIMATES ONLY

** DIRECT WIRE CANADA

NEW 22" KM Series

More Room - Easier to Load

Skutt now offers a line of kilns that provides the perfect mix of height and volume for those artists and teachers who have difficulty opening and loading a 27" deep kiln due to the height.



KM822

- The compact and versatile KM822 is the perfect blend of a home studio model and a great production studio kiln.
- Cone 10 power makes it perfect for porcelain.
- The one of a kind size of the KM822 makes this kiln an amazing asset for any ceramic artist.
- Optional 3" brick upgrade makes this model a more efficient high fire kiln.

(Please note that with added insulation, the chamber diameter is reduced by 1".)



KM1022

- With its Cone 10 power and 5.7 cubic-foot chamber capacity there will be very few projects the KM1022 can't handle.
- The size of this kiln makes it convenient for many locations while not compromising firing performance.
- The size of the KM1022 offers the wide capacity of a large kiln coupled with the easy loading height of a smaller kiln. Great for platters!
- Optional 3" brick upgrade makes this model a more efficient high fire kiln.

(Please note that with added insulation, the chamber diameter is reduced by 1".)



Loading the KM1222-3

The height of the 22" Kiln Series places the pivot point of the waste at or below the top of the kiln for most people.



KM1222-3"

- The 8.1 cubic foot firing chamber will make the KM1222-3" popular with schools, contemporary studios and production bisque companies.
- When coupled with an EnviroVent2, this kiln with its KilnMaster Controller gives precise repeatable firings time after time.
- Lid Lifter and 3-inch brick are standard on this model.

MODEL	PHASE	VOLTS	AMPS	WATTS	CONE	TEMP °F	CU. FT.	OPENING	DEPTH	*SHIP WT LBS	COPPER WIRE SIZE	BREAKER SIZE	NEMA RECEPTACLE CONFIG.
KM822	1	240	33.4	8000	10	2350	3.2	17.5"	22"	170	8	50	6-50
	1	208	38.5	8000	10	2350	3.2	17.5"	22"	170	8	50	6-50
KM822-3"	1	240	33.4	8000	10	2350	2.9	16.5"	22"	180	8	50	6-50
	1	208	38.5	8000	10	2350	2.9	16.5"	22"	180	8	50	6-50
KM1022	1	240	48.0	11520	10	2350	5.7	23.38"	22"	240	6	60	6-50**
	1	208	48.0	9984	10	2350	5.7	23.38"	22"	240	6	60	6-50**
	3	240	34.6	11520	10	2350	5.7	23.38"	22"	240	8	50	15-50
	3	208	34.6	9984	10	2350	5.7	23.38"	22"	240	8	50	15-50
KM1022-3"	1	240	48.0	11520	10	2350	5.25	22.38"	22"	298	6	60	6-50**
	1	208	48.0	9984	10	2350	5.25	22.38"	22"	298	6	60	6-50**
	3	240	34.6	11520	10	2350	5.25	22.38"	22"	298	8	50	15-50
	3	208	34.6	9984	10	2350	5.25	22.38"	22"	298	8	50	15-50
KM1222-3"	1	240	48.0	11520	10	2350	8.1	28.13"	22"	330	6	60	6-50**
	1	208	48.0	9984	8	2300	8.1	28.13"	22"	330	6	60	6-50**
	3	240	34.6	11520	10	2350	8.1	28.13"	22"	330	8	50	15-50
	3	208	40.0	11520	10	2350	8.1	28.13"	22"	330	8	50	15-50

* SHIPPING WEIGHTS ARE ESTIMATES ONLY

** DIRECT WIRE CANADA

Home Studio Kilns



KM818

- The compact and versatile KM818 is a great home studio model.
- Cone 10 power makes it perfect for porcelain.
- 30-amp Cone 8 model available. (3" brick only)



KM714

- The KM714 provides big features in a small size.
- Excellent size for doll artists.
- Automatic controls make it versatile enough to fire just about any material.



KM614-3"

- Make yourself at home with the KM614-3, an economical test kiln with precision control.
- Runs on a 115 volt current with a 30 amp breaker, so it can be set up in nearly any residence.
- Light weight makes it easy to move or take with you.

MODEL	PHASE	VOLTS	AMPS	WATTS	CONE	TEMP °F	CU. FT.	OPENING	DEPTH	*SHIP WT LBS	COPPER WIRE SIZE	BREAKER SIZE	NEMA RECEPTACLE CONFIG.
KM818	1	240	27.8	6660	10	2350	2.6	17.5"	18"	145	8	40	6-50
	1	208	26.7	5550	10	2350	2.6	17.5"	18"	145	8	40	6-50
KM818-3"	1	240	27.8	6660	10	2350	2.3	16.5"	18"	160	8	40	6-50
	1	208	26.7	5550	10	2350	2.3	16.5"	18"	160	8	40	6-50
KM818-30A-3"	1	240	21.7	5200	8	2300	2.3	16.5"	18"	160	10	30	6-30
	1	208	24.0	4990	8	2300	2.3	16.5"	18"	160	10	30	6-30
KM714	1	208-240	20.0	3600	8	2300	1.4	14.38"	13.5"	95	10	30	14-30
KM614-3	1	115	20.0	2300	6	2250	0.8	11"	13.5"	88	10	30	5-20 (5-30 CANADA)

*SHIPPING WEIGHTS ARE ESTIMATES ONLY

GlazeTech Kiln

This is a true Cone 10 Test Kiln.

Unlike most test kilns, the GlazeTech is designed to run on 240V. This gives us the power we need to design a truly useful chamber size. It's square design makes it perfect to fire test tiles on multiple levels and with it's 9" depth, you can actually test short cylinders to see how your glaze performs on a vertical surface. Also makes a great home studio kiln for all of your ceramic needs. The optional rolling stand brings it up to waist high for easy loading.



PHASE	VOLTS	AMPS	WATTS	CONE	TEMP °F	CU. FT.	OPENING	DEPTH	*SHIP WT LBS	SHIP SIZE	COPPER WIRE SIZE	BREAKER RECEPTACLE	NEMA RECEPTACLE CONFIGURATION
1	240	17	4000	10	2350	1.1	14.5"	9"	130	14 cu. ft.	12	20	6-20
1	208	20	4000	10	2350	1.1	14.5"	9"	130	14 cu. ft.	10	30	6-30

NEW

FireBox8 w/KMLT Controller

Great Test Kiln - Household Voltage

If you have been looking for a fast little Cone 10 test kiln that runs on standard household voltage, look no further. The 3 button controller may look simple, but it has nearly all the programming capability of the KilnMaster controller including Ramp and Hold and ConeFire Mode. Also great for fusing glass, PMC clay, and anything else small.



PHASE	VOLTS	AMPS	WATTS	CONE	TEMP °F	CU. FT.	OPENING	DEPTH	*SHIP WT LBS	SHIP SIZE	COPPER WIRE SIZE	BREAKER RECEPTACLE	NEMA RECEPTACLE CONFIGURATION
1	110	15	1725	10	2350	0.17	8" x 8"	4.5"	53	4.6 cu. ft.	12	20	5-15

*SHIPPING WEIGHTS ARE ESTIMATES ONLY

Production

The Skutt Production Kiln (PK) line was designed to handle the rigorous demands of high-volume ceramic manufacturers and high-fire artists. In production, time is money. PK kilns are designed to save you both.

Everything about the PK line is geared towards increasing overall performance and decreasing production time, maintenance cost and downtime.

The optional Lid Lifter makes opening your kiln lid safe and effortless.

The elements in all PK kilns are balanced on 3 different levels of the kiln in order to place the heat where it is needed most.

The mercury relays and heavy gauge high temperature feeder wire should never need replacing and the busbar design makes changing elements a snap.

And the power designed into these kilns allows you to turn even the heaviest Cone 10 loads without wasting time stalling out on the high end. This ability to fire and cool fast will increase production, save energy, and increase element life. Remember you can always program the kiln to fire slower if needed.

KM1627-3" PK OVAL

When you're looking for an oval kiln, you want a great performer, and the KM1627-3" PK delivers. It offers the performance, power and features you need to get the job done right.

- **IT'S BIG.** The massive 18.5 Cubic foot firing chamber can handle almost any project you throw at it. Whether it is large sculptures or huge volumes of tile this kiln has the room to get it done.
- **IT'S TOUGH.** Due to their large surface area, oval kilns are notorious for cracking lids and slabs. Skutt uses a lightweight fiber lid along with fiber inserts on the slab to help prevent this cracking. The special fiber, which is pre-shrunk and rigidized for strength, also limits the amount of heat that escapes through the lid and slab.
- **IT'S ACCURATE.** The KM1627-3" comes standard with Zone Control. It can also be ordered with a special 2 piece EnviroVent system that keeps the atmosphere clean and the temperature uniform.

Optional Lid Lifter available



- **IT'S LOADED.** The KM1627-3 PK comes standard with these great features:



ELEMENT BUSBAR

Newly designed, the busbar system allows for a secure connection and easy element replacement. The busbar bolts are plated to resist corrosion.



LID BRACES

The lid braces on the oval kiln employ cams which allow the user to raise and lower the lid without having to take their hands off of the lid handles.



KILN INSERT

We've used a 1" thick fiber insert which rests on the bottom slab and protects it from heat stress. This not only prevents cracking, it improves heat uniformity in the kiln chamber.



ZONE CONTROL

Zone Control helps even out heat uniformity in unbalanced loads. The KM1627-3" PK can be programmed for either 3-zone control or single-zone which offers faster firing times.

Kiln Line



KM1231-3" PK

- IT'S TALL. This is the tallest automatic kiln Skutt offers. Perfect for tall sculptures or those times when you wished you could fit one more layer in the kiln.
- SMALL FOOTPRINT. When floor space is at a premium the KM1231-3" PK can handle a lot of volume without taking up the space that wider kilns do.



KM1227-3" PK

- THE INDUSTRY STANDARD. Other have tried to duplicate this model but no one has matched the quality and performance of this industry workhorse. Chances are if you are in High fire Production you already own a KM1227-3" PK.
- PERFECT FOR CRYSTAL GLAZE FIRING. Add APM elements and a Type S Thermocouple and you have the perfect crystal glaze kiln.

MODEL	PHASE	VOLTS	AMPS	WATTS	CONE	TEMP °F	CU. FT.	OPENING	DEPTH	*SHIP WT LBS	COPPER WIRE SIZE	BREAKER RECEPTACLE	NEMA RECEPTACLE CONFIG.
KM1627-3"PK		240	66.0	23600	10	2350	18.5	46x30.75"	27"	535	3	90	Direct Wire
		208	76.0	23600	10	2350	18.5	46x30.75"	27"	535	3	100	Direct Wire
KM1627-3"PK1F	1	240	68.0	16300	1	2100	18.5	46x30.75"	27"	535	3	90	Direct Wire
		208	69.0	14300	1	2100	18.5	46x30.75"	27"	535	3	90	Direct Wire
	3	240	46.0	16300	1	2100	18.5	46x30.75"	27"	535	6	60	Direct Wire
		208	47.0	14300	1	2100	18.5	46x30.75"	27"	535	6	60	Direct Wire
KM1231-3"PK	1	240	72.0	17300	10	2350	11.6	28.13"	31"	450	3	90	Direct Wire
		208	80.0	16640	10	2350	11.6	28.13"	31"	450	3	100	Direct Wire
	3	240	44.5	17300	10	2350	11.6	28.13"	31"	450	6	60	Direct Wire
		208	51.5	17300	10	2350	11.6	28.13"	31"	450	4	70	Direct Wire
KM1227-3"PK	1	240	60.0	14300	10	2350	9.9	28.13"	27"	410	4	80	Direct Wire
		208	69.0	14300	10	2350	9.9	28.13"	27"	410	3	90	Direct Wire
	3	240	40.0	14300	10	2350	9.9	28.13"	27"	410	8	50	Direct Wire
		208	46.7	14300	10	2350	9.9	28.13"	27"	410	6	60	Direct Wire

*SHIPPING WEIGHTS ARE ESTIMATES ONLY

Front Loading Kilns



MODEL	PHASE	VOLTS	AMPS	WATTS	CONE	TEMP °F	CU. FT.	HEIGHT	WIDTH	DEPTH	*SHIP WT LBS	COPPER WIRE SIZE	BREAKER SIZE	NEMA RECEPTACLE CONFIG
KM14F	1	240	70	17000	10	2350	14	36"	26.5"	25.75"	*1000	3	90	DIRECT WIRE
	1	208	82	17000	10	2350	14	36"	26.5"	25.75"	*1000	2	110	DIRECT WIRE
	3	240	40	17000	10	2350	14	36"	26.5"	25.75"	*1000	8	50	DIRECT WIRE
	3	208	48	17000	10	2350	14	36"	26.5"	25.75"	*1000	6	60	DIRECT WIRE
KM16F	1	240	80	19000	10	2350	16	36"	26.5"	28.0"	*1100	3	100	DIRECT WIRE
	1	208	92	19000	10	2350	16	36"	26.5"	28.0"	*1100	1	125	DIRECT WIRE
	3	240	46	19000	10	2350	16	36"	26.5"	28.0"	*1100	6	60	DIRECT WIRE
	3	208	53	19000	10	2350	16	36"	26.5"	28.0"	*1100	4	70	DIRECT WIRE

*SHIPPING WEIGHTS ARE ESTIMATES ONLY

KM16F and KM14F

The New Front Loading Kilns from Skutt make loading your kiln like reaching in the refrigerator. It was developed with the input of working artists for maximum performance, ergonomics, and efficiency. There are two models available, the KM16F and the KM14F. The KM 14F was sized to be less deep so it could fit through smaller doorways if that is a concern.

■ Built-in Vent

Downdraft Vent included. Exhausts fumes from the kiln directly outside and improves firing results.

■ Automatic Power Shut-off Switch

Power is shut-off to the heating coils when the door is opened automatically.

■ Zone Control Standard

3 Zone control standard for more even firing results.

■ KilnMaster Controller

Easy to program, KilnLink ready with built in diagnostics.

■ Elements in the Floor

Many kilns fire cool on the bottom. This one fires evenly throughout.

■ Light Weight Door and Roof Design

Fiber roof and door provide improved insulation and life.

■ Easy Change Element Design

Elements are faster and easier to change so they will save you money on kiln maintenance.

■ Durable/Reflective Fiber Coating

Fiber is coated with a refractory coating that strengthens the fiber and improves heat uniformity.

■ Solid State Relays

Solid State relays are standard for long life and limited maintenance.

■ Built-In Heavy Duty Zinc Coated Stand

This heavy duty zinc coated stand is built-in for added strength and stability.

■ Innovative Wall Design

Wall design combines brick, fiber and air to provide maximum durability and efficiency.

■ Sized to Fit Through Standard Doorway

Remove the door (4 Bolts) and the model KM14F will pass through a 34" or larger doorway.



Porcelain Artist Tom Turner

Furniture Kit

Kit Includes

(8) 1" Thick 12" x 24" Shelves,
(8 ea.) 1", 2", 3", 4", 5", 6" and 7" Posts

Available Upgrades

Model	Type S Thermo	APM Elements	Wheels	Zone Control
KM16F/KM14F	★	★	★	■
	★ Upgrade available		■ Come standard on this model	



What is KilnLink

KilnLink is a cloud based Kiln Monitoring System that allows you to check the status of your kiln from anywhere you have access to the internet.

How Does it Work

KilnLink connects your kiln to the internet and feeds information from each firing in real time to the KilnLink Database. Authorized users just log on to their account using a computer or smart phone connected to the internet. You can even set it up to send you Email or Text alerts.

What Type of Information Can I Obtain

The easy to navigate screens will allow you to find the following information:

Current Status

- Current Temperature
- Graph of Firing
- Current Program
- List of Kilns Connected
- Kiln Details
- Communication Info

Know what your kiln is doing at all hours of the day no matter where you are. You can check the current temperature, view a graph of the firing, even check multiple kilns. The peace of mind you will gain from knowing your kiln is safely off is invaluable.



Firing History

All of your firings are logged on the server so you can go back and check your notes to see what has worked in the past. You can also monitor the costs of your electrical use for budgeting purposes.

- Graphs of Every Firing
- Programs Run
- Start and End Times
- Firing Costs
- Firing Notes
- Performance

Diagnostics



Checking the amperage and voltage of your kiln is necessary at times in order to diagnose problems and anticipate maintenance. This can be expensive to hire a professional. With KilnLink

all of that data is logged without even having to open the control box.

Date/Time	Status	Amps 1	Amps 2	Amps 3	Voltage - No Load
Feb 22 2012 2:58PM	Firing	12	12	18	249
Feb 22 2012 2:43PM	Firing Complete	12	12	18	251
Feb 15 2012 10:28PM	Firing	12	12	18	251
Feb 15 2012 2:55PM	Idle	12	12	18	251
Feb 15 2012 2:58PM	Firing Complete	12	12	18	251

KilnLink™

Why Should My School Buy KilnLink

Save Time and Gain Freedom

It seems everyday our schedules get tighter and tighter. Most teachers are required to monitor their kilns. KilnLink gives teachers the freedom to know what is going on with their kiln without having to go to the kiln room. That means more time with the students and more freedom for the teacher. Often times it is not realistic to keep a teacher at school for the entire length of a kiln firing. KilnLink can keep Ceramics a viable option for schools. Art Coordinators can even be authorized to view all the kilns in their district.

Save Money and Down Time

Kiln Maintenance can be expensive and unpredictable. With KilnLink, Skutt technicians can pull up all the data they need to diagnose your kiln and avoid multiple trips from your kiln repair contractor. Your contractor can also be authorized so they can evaluate each kiln for future maintenance and handle problems before they happen.

Monitor Firing Costs

Districts can more closely monitor and budget firing costs by using KilnLink. After every firing, the kiln logs what the electrical cost was for each firing. Schools can evaluate these costs and make cost saving changes by eliminating wasteful practices. Here are just a few examples of changes that can save money:

- Identify and eliminate inefficient firing programs.
- Restrict the maximum temperature allowed in a program.
- Only allow teachers to fire their kilns when electrical rates are lower (when possible).
- Identify kilns that are firing inefficiently due to poor maintenance.



How Do We Get Started

Contact Skutt

Skutt representatives can help you get started, whether you are adding a single system to your home or converting an entire school district. When you call Skutt we will help you evaluate your current inventory of kilns and work with a local distributor to get you a quote.

Installation

Once the quote has been approved, we will work with a local distributor to install the systems. Some kilns may require controller upgrades depending on their age. Once the systems are in place, we will help guide you through activating each location, authorizing users, and setting up alerts. After that, you are up and ready to go.

KilnLink - Single Kiln Installation

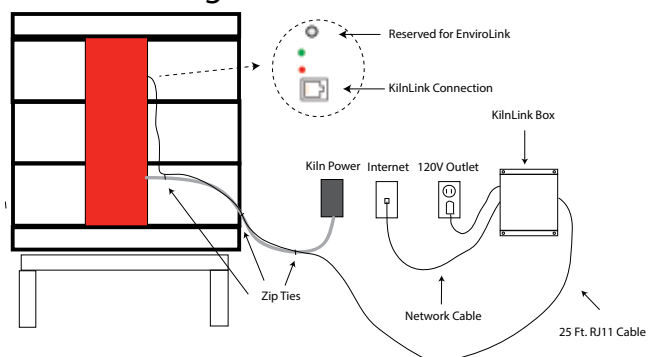

The Transformer Package

Experience the freedom of being able to fire tall pots without having to purchase a large kiln that will be used only on an occasional basis. **Here is how it works:**

Purchase two or three KM1 227PK kilns with a transformer Upgrade Package. The package must be installed at the time of the order. Use the kilns as you would normally on a daily basis and when you are ready to stack, follow the steps below.

When it comes time to fire a large pot or sculpture here is what you do:

- Remove the lid and control boxes.
- Stack the sections around your piece.
- Place one of the lids on top of the kiln.
- Reinstall the boxes and connect them with the cords provided in your package.
- Program the kilns to fire in unison and press start.



Artist Scott Semple prepping a 75" pot for firing.



Stack two or three kilns depending on the height you need. The exclusive software available only through Skutt allows each kiln to communicate with the others so they fire in perfect unison. PK kilns fire to Cone 10 and are equipped with all of the industrial components that will make these kilns the workhorses of your studio.

PACKAGE INCLUDES

- 15 foot power cords - so the kilns can be stacked and still reach their dedicated outlet.
- Communication ports - allows connection between controllers.
- One heavy-duty welded stand (in addition to the stands that come with the kilns).
- All wiring necessary to connect the controllers.
- Zone Control - 3 thermocouples per kiln for precise temperature control top to bottom.

Make a great KilnMaster kiln even better with these upgrades

Type S Thermocouple

- Type S are the most accurate thermocouples available and do not degrade under the harsh environment of Cone 6 and Cone 10 firings. This could be the last thermocouple you ever have to buy. (Requires special controller and thermocouple wire. Please consult with your distributor or Skutt on existing kiln upgrades.)

APM Elements

- Kanthal APM elements are different from standard elements because they are manufactured from powdered material. This new technology provides improved dimensional stability at higher temperatures which results in significantly longer element life. If you are firing Crystal Glaze or consistently firing Cone 10 materials, these elements are highly recommended.

Energy Saving 3" Brick

- 3" brick provides better insulation and higher energy savings by increasing the brick thickness from standard 2-1/2" size. This upgrade is recommended for high-fire models. 3" firebrick increases the temperature rating and slows cooling.
- A model shown in chart with "-3" designation means it comes standard on the model.



Zone Control

- Zone control is a feature that allows the kiln to fire each section of the kiln independently. This is done by placing a thermocouple in each section of the kiln. The controller reads each thermocouple and cycles each section on or off if it varies too much from the desired program. It is a great way to even out the heat in the kiln when the load is not uniform. It is also great for firing glass. Zone control will not work well on kilns without a very high power to volume ratio, therefore it is only available as an upgrade on certain models. This feature is standard on the KM1627PK.



Lid Lifter

- All 10 and 12 sided models now come standard with a Lid Lifter. The Lid Lifter makes opening your kiln safe and effortless. The Lid Lifter also comes standard with a 3 position lid prop and 2 position lid brace for added safety and convenience. Lid Lifter upgrade kits are also available to easily install on older 10 and 12 sided models as well as the KM1627-3PK.



Model	Type S Thermo	APM Elements	3" Brick	Zone Control	Lid Lifter
KM1627-3"PK	★	★	■	■	★
KM1627-3"PK-LF	★	★	■	∅	★
KM1231-3"PK	★	★	■	★	■
KM1227-3"PK	★	★	■	★	■
KM1227-3"	★	★	■	∅	■
KM1222-3	★	★	■	∅	■
KM1218-3"	★	★	■	∅	■
KM1027	★	★	★	∅	■
KM1027-3"	★	★	■	*	■
KM1022	★	★	★	∅	■
KM1022-3	★	★	■	∅	■
KM1018	★	★	★	∅	■
KM1018-3"	★	★	■	∅	■
KM822	★	★	★	∅	∅
KM822-3	★	★	■	∅	∅
KM818	★	★	★	∅	∅
KM818-3"	★	★	■	∅	∅
KM714	★	★	∅	∅	∅
KM614-3"	★	★	■	∅	∅
GLAZETECH	★	★	■	∅	∅
FireBox 8 w/KMLT	★	★	∅	∅	∅

★ Upgrade available
 ∅ Upgrade not available
 * Available for all KM1027-3 except 208 single phase
 ■ Come standard on this model

Rolling Stands

- This optional heavy duty stand is perfect for rolling the kiln out of the way when not in use. Welded, powder coated square tube frame with steel locking wheels that won't develop flat spots. Regulation height.



The KilnSitter

Reliable kiln

KilnSitter Controllers have been used reliably on Skutt Kilns for over 50 years. Many artists still prefer the traditional close interaction of firing a kiln manually.

The KilnSitter is a mechanical control that fires your kiln by the time and temperature method of heat



treatment using pyrometric cones or bars. After being exposed to the proper time and temperature (heatwork), the cone or bar softens and bends to a predetermined angle, shutting off the kiln.

The temperature and heating rate of KilnSitter (KS) kilns are controlled by switches that

you turn up in intervals.

A unique feature of the KilnSitter line of Skutt kilns is that all models (except the KS614-3" and the KS609) can be expanded by inserting a 4.5" brick ring between the sections. It should be noted that the use of the ring limits the maximum firing temperature to Cone 1 (2100°F) for most models. This ring can be added or removed between firings.

Limits timers should always be ordered as a safety backup to prevent over fires. They are listed as an optional feature and must be ordered at the time the kiln is ordered.



KS1227-3"



■ The KS1227-3" is an excellent low fire production kiln. With 9.9 cubic feet of space, it has ample size to handle all your work. Each section has its own 3 heat switch so you can adjust the power of each section separately.

MODEL	PHASE	VOLTS	AMPS	WATTS	CONE	TEMP °F	CU. FT.	OPENING	DEPTH	*SHIP WT LBS.	COPPER WIRE SIZE	BREAKER RECEPTACLE	NEMA RECEPTACLE CONFIG.
KS1227-3"	1	240	48.0	11520	8	2300	9.9	28.13"	27"	410	6	60	6-50**
		208	48.0	9984	5	2185	9.9	28.13"	27"	410	6	60	6-50**
	3	240	29.3	11520	8	2300	9.9	28.13"	27"	410	8	40	15-50
		208	31.7	11000	8	2300	9.9	28.13"	27"	410	8	40	15-50

*SHIPPING WEIGHTS ARE ESTIMATES ONLY

**DIRECT WIRE CANADA

Manual Kiln Line

control for over 50 years



KS1027



- The KS1027 is our most popular manual kiln, and its Cone 10 rating and 7 cubic-foot chamber size makes it extremely flexible.

KS1018



- The KS1018 has a low profile design for easy loading and unloading.
- It's large opening accommodates big pieces - perfect for heavy sculpture work.

KS818



- Studio workhorse - small size but big Cone 10 power.
- Compact dimensions allow it to fit into tight spaces.

MODEL	PHASE	VOLTS	AMPS	WATTS	CONE	TEMP °F	CU. FT.	OPENING	DEPTH	*SHIP WT LBS	COPPER WIRE SIZE	BREAKER RECEPTACLE	NEMA RECEPTACLE CONFIG.
KS1027	1	240	48.0	11520	10	2350	7.0	23.38"	27"	290	6	60	6-50**
		208	48.0	9984	6	2250	7.0	23.38"	27"	290	6	60	6-50**
	3	240	29.3	11520	10	2350	7.0	23.38"	27"	290	8	40	15-50
		208	31.7	11000	10	2350	7.0	23.38"	27"	290	8	40	15-50
KS1027-3"	1	240	48.0	11520	10	2350	6.4	22.38"	27"	320	6	60	6-50**
		208	48.0	9984	10	2350	6.4	22.38"	27"	320	6	60	6-50**
	3	240	29.3	11520	10	2350	6.4	22.38"	27"	320	8	40	15-50
		208	31.7	11000	10	2350	6.4	22.38"	27"	320	8	40	15-50
KS1018	1	240	39.4	9460	10	2350	4.6	23.38"	18"	250	8	50	6-50
		208	40.0	8320	10	2350	4.6	23.38"	18"	250	8	50	6-50
KS1018-3"	1	240	39.4	9460	10	2350	4.2	22.38"	18"	275	8	50	6-50
		208	40.0	8320	10	2350	4.2	22.38"	18"	275	8	50	6-50
KS818	1	240	27.8	6660	10	2350	2.6	17.5"	18"	145	8	40	6-50
		208	26.7	5550	10	2350	2.6	17.5"	18"	145	8	40	6-50
KS818-3"	1	240	27.8	6660	10	2350	2.3	16.5"	18"	160	8	40	6-50
		208	26.7	5550	10	2350	2.3	16.5"	18"	160	8	40	6-50

*SHIPPING WEIGHTS ARE ESTIMATES ONLY

**DIRECT WIRE CANADA

KilnSitter Kilns



KS714

- Get started! The KS714 is the ideal kiln for beginners and china painters.
- Great for studios firing small loads.



KS614-3"

- The KS614-3" delivers big results in a small size.
- Perfect for doll pieces or other small works.
- 115 volt, 30 amp electrical circuit, makes it usable in many residences.



KS609

- Great for beginners and apartment dwellers.
- Efficient way to test glazes and clay bodies in larger studios.
- Requires only 115 volt, 20 amp electrical circuit, which is available in almost any home or apartment.

MODEL	PHASE	VOLTS	AMPS	WATTS	CONE	TEMP °F	CU. FT.	OPENING	DEPTH	*SHIP WT LBS	COPPER WIRE SIZE	BREAKER RECEPTACLE	NEMA RECEPTACLE CONFIG.
KS714	1	240	20.0	3600	8	2300	1.4	14.38"	13.5"	95	10	30	14-30
		208	20.0	3600	8	2300	1.4	14.38"	13.5"	95	10	30	14-30
KS614-3"	1	115	20.0	2300	6	2250	0.8	11"	13.5"	88	10	30	5-20
													5-30 Canada
KS609	1	115	17	1950	6	2250	0.6	11"	9"	60	12	20	5-15

*SHIPPING WEIGHTS ARE ESTIMATES ONLY

Increase the flexibility of a KilnSitter kiln with these Upgrades

KM-1 Wall Mount Controller



- Converts KilnSitter Manual Kilns to the convenience and precision of an automatic.
- Easy to mount at eye level, so you can monitor a firing without bending or stooping.
- Easy to clean, sealed touch pad faceplate.
- Easy to install, just drill a small hole through your kiln's firebrick for the KilnMaster thermocouple (the stainless steel jacket is already punched on Skutt Kilns) and plug your kiln into the unit.

Model	Phase	Phase		NEVA Receptacle Config.
KM-1	1	208-240	Switching Capacity 48 AMPS	6-50
KM-1	3	208-240	Switching Capacity 40 AMPS	15-50

Blank Ring

- A blank ring is a 4.5" extension that may be added to most Skutt KilnSitter models to increase the height and overall capacity of the kiln. On multi-section kilns, the ring fits between the master section and the top section. Due to the fact that blank rings increase the volume of the kiln without adding more power, the maximum Cone rating when fired with a blank ring is reduced to Cone 1. The ring can be added or removed when necessary.



Limit Timer



- A limit timer is always a recommended upgrade for KilnSitter Kilns. The Limit Timer acts as a safety shutoff device in case the KilnSitter malfunctions. It is factory installed in the face of the KilnSitter unit and is extremely easy to operate.

Pyrometer



- If you are ordering a KilnSitter kiln you may want to equip it with a Skutt Analog or Dual Input Digital Pyrometer. A pyrometer will let you know what the temperature of the kiln chamber is throughout the entire firing. This is especially helpful to know when you are firing glass, heat treating metal or troubleshooting your kiln. Both pyrometers come complete with a Type K thermocouple and all the mounting hardware needed.

Energy-Saving 3" Brick



- 3" brick provides better insulation and higher energy savings by increasing the brick thickness from the standard 2-1/2" size. This upgrade is recommended for high-fire models. High quality firebrick increases the temperature rating and slows cooling. A model shown with a "-3" designation means 3" brick comes standard.

Lid Lifter



- All 10 and 12-sided models now come standard with a Lid Lifter. The Lid Lifter makes opening your lid safe and effortless. The Lid Lifter also comes standard with a 3 position lid prop and 2 position lid brace for added safety and convenience. Lid Lifter upgrade kits are also available to easily install on older models.

Rolling Stand

- See page 22 for details

Model	KM-1 Wallmount	Blank Ring	Pyrometer	3" Brick	Lid Lifter
KS1227-3"	★	★	★	■	■
KS1027	★	★	★	★	■
KS1027-3"	★	★	★	■	■
KS1018	★	★	★	★	■
KS1018-3"	★	★	★	■	■
KS818	★	★	★	★	∅
KS818-3"	★	★	★	■	∅
KS714	∅	★	★	∅	∅
KS614-3"	∅	∅	★	■	∅
KS609	∅	∅	★	∅	∅

■ Come standard on this model
 ★ Upgrade available
 ∅ Upgrade not available

Accessorize

Optional equipment to get

NEW! The Lid Lifter



■ All 10 and 12-sided models now come standard with a lid lifter. The Lid Lifter makes opening your lid safe and effortless. The Lid Lifter also comes standard with a 3 position lid prop and 2 position lid brace for added safety and convenience. Lid Lifter upgrade kits are also available to easily install on older models.

NEW! KilnLink

■ This system allows you to monitor your kiln from anywhere you have an internet connection, including your smart phone. It also keeps a permanent record of all of your firings including graphs of the firing and diagnostic information. Gain the peace of mind of knowing exactly what your kiln is doing no matter where you are. For more information see pages 19 and 20.

NEW! EnviroLink

■ The EnviroLink allows you to program the controller to automatically turn the vent on and off throughout a firing program. You simply enter an on/off setting for each segment of a Ramp and Hold program while you are programming the kiln. There are preset "vent programs" that can be run in conjunction with a Cone Fire Mode program as well.

Replacement Parts

■ All replacement parts are available for purchase through your distributor. Overnight delivery is available for most items.

NEW! EasyView



■ Angled touchpad mount for easy viewing and programming. Can be ordered with a new kiln or as an upgrade to an existing kiln. Installs in minutes. Available for all KilnMaster Kilns.

Furniture Kits

■ A furniture kit is used to create shelf layers inside your kiln. Although the contents of shelf kits vary depending on the kiln model, all shelf kits will contain a selection of shelves and 1 or more post assortment kits. Furniture kits for kilns with 8 sides or less will come with



18 posts, 3 each in lengths 1" through 6". Kits for larger kilns will come with 36 posts. New lighter 5/8" shelves are now available for most models. All kits come with an 8 ounce bag of kiln wash.

MODEL	Kit Includes
1627	(8) 1" 1227 half shelves, (8) 1x1.3x1.6" shelves (5) Small Post Assortment Kits
1231/1227	(8) 1" or 5/8" half shelves, (1) Large Post Assortment
1218/1222	(6) 1" or 5/8" half shelves, (1) Large Post Assortment
1027	(8) 5/8" half shelves, (1) Large Post Assortment
1018/1022	(6) 5/8" half shelves, (1) Large Post Assortment
818/822	(2) 5/8" full shelves, (3) 5/8" half shelves, 1 Small Post Assortment
714	(1) 5/8" full shelf, (1) 5/8" half shelf, 1 Small Post Assortment
614-3	(1) 1/2" full shelf, (1) 1/2" half shelf, 1 Small Post Assortment
609	(1) 1/2" full shelf, (1) 1/2" half shelf, 1 Small Post Assortment
GlazeTech	(4) 5/8" full shelves, (12) 1" posts
FireBox 8	(1) 5/8" full shelf, (3) 1" posts

1" thick shelves are recommended for use in high fire applications in kilns 1227-3 or larger.

See page 18 for information on the KM16F and KM14F furniture kits.

your kiln

the most from your kiln

The EnviroVent 2



- **Removes fumes**, odors and vapors. Particularly useful when firing materials such as lusters, metallics and high sulfur clays, which can emit strong odors.
- **Improves firing consistency**. The vent also helps to prevent different color glazes from migrating. You can now fire greens and reds on the same shelf with excellent results.
- **Fits popular kilns**. The EnviroVent 2 fits Skutt 12, 10 and 8-sided kilns, as well as many other kiln brands.
- **Ideal for automatic kilns**. The EnviroVent 2 makes firing kilns such as the Skutt KM series much more convenient. There's no lid propping. Just put plugs in all the peepholes and press START.
- **Better than hoods**. The EnviroVent 2 pulls fumes from the kiln before they can enter the room. It's compact and unobtrusive - no pulleys, no counterweights, no overhead installation. Flexible ducting lets you move kilns around the room. And the air-cooled motor will not overheat from normal firings.
- **Certified safe**. The EnviroVent 2 is UL listed when installed with a Skutt kiln bearing the UL mark and meets standard building codes in most jurisdictions.
- **Easy to install**. The EnviroVent 2 is easy to install on new or existing kilns. The kit includes everything you need for a floor or wall mounted installation. We can drill the venting holes at the factory when the kiln is ordered or they can be easily drilled on site. We even give you the drill bit. Vent through the roof or the wall of your kiln room.

- **Won't leak**. The spring-loaded plenum cup ensures a tight seal as the kiln heats up. The floor of the kiln actually cups when the kiln is fired causing competitive brand vents to quit drawing air.
- **Meets code**. The new wall mounted EnviroVent 2 design is a Negative Pressure System which prevents fumes from leaking into the room if the duct is damaged. Negative pressure systems are required by some local building codes. Mounting the motor away from the kiln protects it from heat and prevents vibration from transferring to the kiln.
- **Vent 2 Kilns**. With the addition of the Dual Intake Kit, you can vent 2 kilns under 12 cubic feet each with 1 motor or any kiln up to 24 cubic feet.

■ Vent Accessories.

EnviroLink: Allows you to program the KilnMaster Controller to turn the EnviroVent on or off at the end of the firing or for each segment of a program.

Dual Intake Kit: Allows ducting 2 kilns or kilns over 12 cubic feet (up to 24 cubic feet).

Extension Kit: Additional 8 feet of ducting with connector and clamps.

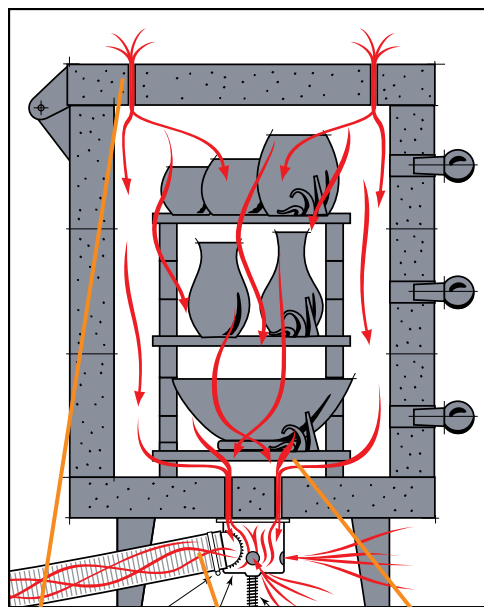

Small amount of air enters at top of kiln.

Fumes, odors and vapors are diluted with cool air and exit to the outside atmosphere.

Negative pressure in the plenum chamber creates a downdraft.

Installation and Electrical

Things to know before you install and use your Skutt kiln

While you're deciding which Skutt kiln is right for you, keep in mind the power requirements of each kiln, and what power is available in your kiln room. In most cases, you will need an electrician to install the proper receptacle and circuit. We recommend wire of adequate size is installed for safety and to assure satisfactory performance of the kiln. See the chart on the next page for the electrical requirements of the entire Skutt kiln line. You can contact your local power company or any electrician to determine what voltage you have (208 or 240 volt supplies) and the amperage limitations you may have at your building.

Power Notes:

LOW VOLTAGE PROBLEMS

Skutt kilns may not operate correctly if you are receiving low voltage from your power line. KS kilns may fire slowly and not reach high fire temperatures. KM controllers may display an error message.

THREE-PHASE INSTALLATION

The 3-phase models KS1027 and KS1227 require a 3-phase contactor box to be used to shut off the kiln. The contactor box comes with a receptacle for the kiln connected to the bottom of the box. The contactor box is included in the price of the kiln.

The 3-phase models KM1027 and KM1227 can be plugged directly into a 3-phase (15-50) wall receptacle.

208 VERSUS 240 SUPPLIES

As you can see from the chart, most Skutt models are available in either 208 or 240 volt versions. The

exceptions are models KS714 and KM714 which are universal, and will fire with 240V or 208V power (614 and 609 models run on 115V). The 208V versions should never be fired on a 240V supply without first installing a full set of 240V elements. Otherwise, all components will be seriously overtaxed. Similarly, the 240 volt kilns should not be used on a 208 volt supply. The elements will not be properly powered and will fail to reach the maximum rated temperatures for that kiln.

NOTES ON THE 714

Connecting and testing models KS714 and KM714: the wall outlets for these models must be powered by 3-wire 120/240-208V solid neutral supply (as for a modern electric clothes dryer). Consult the kiln manual before installation.

A FEW PRECAUTIONS

Please remember that your Skutt kiln reaches high temperatures and should be treated with respect during installation and firing. Read the manual carefully, and follow all recommended safety guidelines. Consult your distributor about installation. They can usually recommend a licensed electrician who has kiln installation experience, which will result in a kiln that can deliver all the performance we design into every Skutt product.

Although automatic controllers allow you to be away from the kiln during firing, we recommend that you monitor the firing periodically and that you always be present near the end of the firing through cool down.

The metal on the outside of the kiln gets extremely hot when the kiln is firing. Be sure to locate it in an area that is clear of combustible materials and protected from small children and pets. Also if you are locating the kiln in a sprinklered, room do not locate the kiln directly under a sprinkler head. You can install the highest temperature sprinkler head possible in accordance with your local building codes and Fire Marshall. Common temperature ratings for sprinkler heads are 165° F, and 286° F. Hotter ratings are available however they require special permits in most cases.

SKUTT CERAMIC PRODUCTS WARRANTY - LIMITED

SKUTT CERAMIC PRODUCTS, INC. warrants this product to be free from defects in materials and workmanship for two full years from the date of the first retail purchase from an authorized Skutt dealer.

What Skutt Will Do. Skutt will repair or replace, at its expense, any defective part upon return, freight prepaid, to any authorized Skutt service center.

What Is Not Covered. This warranty does not cover (1) any defect not reported to an authorized Skutt dealer or distributor within 10 days of discovery; (2) THE KILNSITTER is separately warranted; (3) Type K Thermocouples; (4) any damage caused by over firing; (5) products subjected to abnormal strain, freight damage, neglect, abuse, improper storage, failure to follow instructions, or products altered from factory standard condition; (6) products whose identification number has been changed; (7) failures of, or failures caused by, parts or accessories not manufactured or supplied by Skutt Ceramic Products; (8) kilns used for purposes other than firing ceramic materials; (9) kilns used for reduction or salt firing; and (10) elements in "PK" model kilns.

How To Obtain Warranty Services. Notify your Skutt dealer or distributor within 10 days of discovery of any defect. Deliver any defective part, freight prepaid, to an authorized Skutt service center. A list of Skutt service centers may be obtained from your dealer or from Skutt Ceramic Products, Inc. at the address and telephone number found on the back of this catalog.

Other Limitations. ANY SPECIAL, INCIDENTAL, OR CONSEQUENTIAL DAMAGES, INCLUDING PROPERTY DAMAGE, LOST PROFITS, LOSS OF USE, OR OTHER ECONOMIC LOSS, ARE EXCLUDED TO THE FULL EXTENT PERMITTED BY STATE LAW. Some states do not allow the exclusion of incidental or consequential damages, so the above exclusion may not apply to you. ANY IMPLIED WARRANTIES, INCLUDING THE IMPLIED WARRANTIES OF MERCHANTABILITY AND FITNESS FOR A PARTICULAR PURPOSE, ARE LIMITED IN DURATION TO THE DURATION OF THIS LIMITED WARRANTY. Some states do not allow limitations on how long an implied warranty lasts, so the above limitation may not apply to you. Dealers are not authorized to modify this warranty or to make any additional commitments. Skutt will not be responsible for promises not contained in this warranty.

State Law Rights. This warranty gives you specific legal rights, and you may also have other rights which vary from state to state.

KM/KS MODEL	PHASE	VOLTS	AMPS	WATTS	COPPER WIRE SIZE	BREAKER SIZE	NEMA RECEPTACLE CONFIG.	SAFETY LISTING
1627-3" PK	3 PH	240	66.0	23600	3	90	direct wire	cULus
1627-3" PK	3 PH	208	76.0	23600	3	100	direct wire	cULus
1627-3" PK-LF	1 PH	240	68.0	16300	3	90	direct wire	cULus
1627-3" PK-LF	1 PH	208	69.0	14300	3	90	direct wire	cULus
1627-3" PK-LF	3 PH	240	46.0	16300	6	60	direct wire	cULus
1627-3" PK-LF	3 PH	208	47.0	14300	6	60	direct wire	cULus
1231-3" PK	1 PH	240	72.0	17300	3	90	direct wire	cULus
1231-3" PK	1 PH	208	80.0	16640	3	100	direct wire	cULus
1231-3" PK	3 PH	240	44.5	17300	6	60	direct wire	cULus
1231-3" PK	3 PH	208	51.5	17300	4	70	direct wire	cULus
1227-3" PK	1 PH	240	60.0	14300	4	80	direct wire	cULus
1227-3" PK	1 PH	208	69.0	14300	3	90	direct wire	cULus
1227-3" PK	3 PH	240	40.0	14300	8	50	direct wire	cULus
1227-3" PK	3 PH	208	46.7	14300	6	60	direct wire	cULus
1227-3"	1 PH	240	48.0	11520	6	60	6-50*	cULus
1227-3"	1 PH	208	48.0	9984	6	60	6-50*	cULus
1227-3"	3 PH	240	29.3	11520	8	40	15-50	cULus
1227-3"	3 PH	208	31.7	11000	8	40	15-50	cULus
1222-3"	1 PH	240	48.0	11520	6	60	6-50*	cULus
1222-3"	1 PH	208	48.0	9984	6	60	6-50*	cULus
1222-3"	3 PH	240	34.6	11520	8	50	15-50	cULus
1222-3"	3 PH	208	40.0	11520	8	50	15-50	cULus
1218-3"	1 PH	240	48.0	11520	6	60	6-50*	cULus
1218-3"	1 PH	208	48.0	9984	6	60	6-50*	cULus
1218-3"	3 PH	240	29.3	11520	8	40	15-50	cULus
1218-3"	3 PH	208	29.5	9984	8	40	15-50	cULus
1027/1027-3"	1 PH	240	48.0	11520	6	60	6-50*	cULus
1027/1027-3"	1 PH	208	48.0	9984	6	60	6-50*	cULus
1027/1027-3"	3 PH	240	29.3	11520	8	40	15-50	cULus
1027/1027-3"	3 PH	208	31.7	11000	8	40	15-50	cULus
1022/1022-3"	1 PH	240	48.0	11520	6	60	6-50*	cULus
1022/1022-3"	1 PH	208	48.0	9984	6	60	6-50*	cULus
1022/1022-3"	3 PH	240	34.6	11520	8	50	15-50	cULus
1022/1022-3"	3 PH	208	34.6	9984	8	50	15-50	cULus
1018/1018-3"	1 PH	240	39.4	9460	8	50	6-50	cULus
1018/1018-3"	1 PH	208	40.0	8320	8	50	6-50	cULus
822/822-3"	1 PH	240	33.4	8000	8	50	6-50	cULus
822/822-3"	1 PH	208	38.5	8000	8	50	6-50	cULus
818/818-3"	1 PH	240	27.8	6660	8	40	6-50	cULus
818/818-3"	1 PH	208	26.7	5550	8	40	6-50	cULus
818-30A-3"	1 PH	240	21.7	5200	10	30	6-30	cULus
818-30A-3"	1 PH	208	24.0	4990	10	30	6-30	cULus
818P/818P-3"	1 PH	240	21.7	5200	10	30	6-50	cULus
818P/818P-3"	1 PH	208	24.0	4990	10	30	6-50	cULus
714	1 PH	208/240	20.0	3600	10	30	14-30	**
614-3"	1 PH	115	20.0	2300	10	30	5-20	**
614-3"	1 PH	115	20.0	2300	10	30	5-30 (Canada)	**
609	1 PH	115	17.0	1950	10	20	5-15	**
GlazeTech	1 PH	240	17.0	4000	12	20	6-20	**
GlazeTech	1 PH	208	20.0	4000	10	30	6-30	**
FireBox 8	1 PH	115	15	1725	12	20	5-15	**

KILNMASTER SPECIFICATIONS

- Delay Firing start: up to 99 hours and 99 minutes.
- Cone Fire Mode: Entry by cone number, 3 firing speeds, cone 022 to cone 10.
- Ramp/Hold Mode: Entry by temperature, create programs from 1 to 32 segments. Each segment can specify a rate of heating or cooling to a specified temperature with an optional hold time up to maximum temperature of 2400° F (not recommended to fire over 2350° F).
- Memory holds up to 12 firing programs.
- Safety Features: Power Failure Detection, Thermocouple Failure Detection, Microprocessor Fault Detection.
- Electronic Cone Table: Converts cone numbers to temperature. Digital Readout: Fahrenheit or Centigrade. Program Review: Review program and current segment during firing.
- Temperature Alarm: Adjustable to desired temperature.
- Control Panel: Sealed Touch Pad, washable.
- Thermocouple: Type K.
- Designed and manufactured in the USA.

ENVIROVENT SPECIFICATIONS

- Structural material: Aluminum.
- Duct: 3" diameter, 8' length - U.L. listed - flexible aluminum.
- Power requirements: 115V, 1.4 Amp household current.
- Control: In-line power switch.
- Air volume: 140 cfm.
- Shipping weight: 17lbs.
- U.L. listed vent system when used with Skutt U.L. listed kilns.
- Package includes complete installation and operating instructions, and twist drill set.
- Two year limited warranty.

* Direct Wire Canada

** SAFETY LISTING EXCEPTIONS
 KM614-3" - CSA only
 KS714 UL only
 KS614-3", KS609 and GlazeTech are currently not listed.

NEMA RECEPTACLE GUIDE



Outstanding Service

Over 50 years of Experience

- Founded in 1953 by father and son team, R.W Skutt and Neil Skutt, Skutt Kilns remains a family business focusing on innovation and the needs of the customer.

Most Extensive Nationwide Network of Distributors

- With nearly 200 distributors nationwide, you can be assured that there is a distributor near to assist you with your purchase and provide quality service.

Parts and Labor Warranty

- There are a lot of different warranties on the market. Some offer longer periods, but pro-rate what they will pay. Others pay for parts but not for labor. At Skutt we have a straightforward 2-year parts and labor warranty. The bottom line is that a warranty is only as good as the company behind it. With Skutt, you know we are going to take care of you.

Technical Service there when you need it.



- Our technical department is open 5 days a week Monday thru Friday from 7:30am to 5:00pm. We have full-time technicians available to answer your questions. If you have a problem after hours, we have a comprehensive troubleshooting

web site to help you figure out the problem.

Talk to a Person, Not a Recording

- Our customer service department is connected from the receptionist to the President. It is extremely rare that our phone is not answered by an actual person. If we are busy and you need to talk to someone personally, the phone system will find someone for you, guaranteed!

Most Recommended Kiln on the Market

- We have worked hard to develop our reputation for consistent quality and outstanding customer service over the years. For this reason we are the number one kiln recommended by distributors, art educators and studio owners.



Under-promise and Over-deliver

- At Skutt we rigidly test all our kilns to perform at, and beyond, their maximum capabilities. When Skutt gives a kiln a cone and temperature rating, you can be assured you will receive a lifetime of quality performance. No matter what your application, we have a model designed specifically to meet your needs.

Best Packaging



- Few things are more disappointing than receiving a kiln that has been damaged in freight. Kilns are fragile items to ship. That is why we have invested in the top-of-the-line packaging system to insure the safe delivery of your kiln.

Many of our distributors even offer professional delivery and set-up services. They will physically inspect

every kiln before they deliver. Call your local distributor for details.

Most Parts Ship Within 24 Hours

- We understand that the reputation of your business or education program can be on the line when your kiln is down. That is why we ship replacement parts within 24 hours. If needed, with express delivery, we can even get your parts to you by the next morning.

Get in Contact with Us

- We want to make it easy as possible for you to request and receive the information you need to make a smart purchase. That is why we offer so many ways to reach us.

■ Call us: 503-774-6000

■ Fax us: 503-774-7833

■ E-mail us: skutt@skutt.com

■ Web site: www.skutt.com

Visit Your Local Distributor

- A complete list of authorized Skutt Distributors can be found on our web site. Visit the one nearest you to see the actual kiln up close. Our distributors are experts in their field and should be able to help you pick the best kiln for your specific needs.

Visit Our Website

- Most of our printed product literature can be easily downloaded off our website for more in-depth technical information. You can also find a listing of our distributor network so you can find the dealer nearest you.